

# Gotech-MFI

## Fuel Management Systems

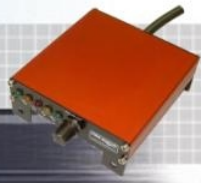

58 Graniet Street, Jet Park, JHB - Tel: 011 3971953 - Fax: 011 3978197



- (F1) - Connect To ECU 19200 n 8.1
- (F2) - Disconnect From ECU
- (F3) - Transfer Saved Map from Disk to ECU
- (F4) - Transfer Map from ECU to Disk
- (F5) - Default ECU Setup Screen
- Water Temp Correction Screen
- Air Temp Correction Screen
- Voltage Correction Screen
- Micro Setup Screen
- Ignition
- All Ranges Up
- Site Value
- Value

[www.gotech.co.za](http://www.gotech.co.za)

0 135 125 115 105 95 85

RPM	0	Inj M /S	5
AFR	10.000	Potentiometer	
Voltage	14.4	36	
Ignition Angle	7	Throttle	22

## MFI Pro TS - Instructional Manual Version 06.01



**Index:**

Introduction	1
Before You Begin	1
Basic Tools Required	2
Basic Components Required	3
Hardware Installation	3
ECU Plug Pinout 16 Pin	4
ECU Plug Pinout 12 Pin	5
ECU Power Supply	6
Fuel Injectors	7
Connecting The Fuel Injectors	8
Ignition Output	9
Coil Charge Time	9
Connecting The Coils	10
RPM Signal Input	11
Connecting The RPM Input Signal	11
Crank Trigger Pickups	12
Crank Trigger Sensors And Wheels	12
Crank Trigger Tooth Compensation	12
Throttle Position Sensor Input	13
Water Temperature Sensor Input	14
Air Temperature Sensor Input	14
Lambda Sensor	15
Lambda Sensor Installation	15
Closed Loop Lambda Control	15
Optional Output	16
Connecting The Optional Output	16
Fuel Pump Output	16
Connecting The Fuel Pump Output	16
Rev Counter Output	17
Launch Control	18

## **Introduction:**

Congratulations on choosing a Gotech engine management system for your vehicle. Gotech MFI systems have been successfully installed on thousands of vehicles, from twin turbo v8's, drag bikes to imported Japanese Toyotas. Over the past years many motor sport enthusiasts have discovered that the Gotech computer is easy to use and gets the job done correctly thus giving excellent reliability and enabling users to precisely control ignition timing and fuelling needs. Precise ignition and fuelling control leads to excellent drive ability and fuel economy.

Gotech MFI is suitable for most four stroke petrol engines from one to eight cylinders. MFI stands for Micro Fuel Injection. Don't be fooled by the "micro" part of the name. Considering the features of this unit, it could just as well be named "Mighty Fuel Injection" The Gotech MFI ecu can be used on normally aspirated or charged vehicles boosting up to 1.5 bar boost (+ - 21psi). A 3 bar (+- 42psi) map sensor is available on request.

## **Before you begin:**

1. It is best to read the entire manual before starting, the greater you knowledge of the Gotech system, the easier you will find it to understand what you are doing, and why. Throughout the manual are warnings and notes that will help your installation run smoothly and indicate the known dangers that exist.
2. Read any additional material accompanying this manual.
3. You may need special parts, additional tools or test equipment in order to complete the installation. Make sure that you have all these items before you begin to avoid frustration.
4. Don't do the minimal work possible. Carelessness in the early stages of installation can cause major headaches later on. Carelessness will cost you money and frustration in finding and fixing unnecessary problems.
5. Electromagnetic interference (EMI) from unsuppressed spark plug leads can cause the ecu to fail. Try keeping all signal wires as far away as possible from high EMI locations. Please use suppressed plug leads at all times. Never use copper or solid core plug leads.

## **Before you begin continued:**

6. In hot climates or with charged vehicles you might have to employ heat shielding to prevent heat soak to electrical and fuel parts.
7. We recommend you having your vehicle dynoed by professionals with the proper equipment.

WARNING - Before starting the Gotech installation:

1. Avoid open sparks, flames or operation of electrical devices near flammable substances.
2. Always disconnect the battery when doing electrical work on your vehicle.
3. Do not charge the battery with a 24 volt truck charger or reverse the polarity of the battery or any charging unit.
4. Do not charge the battery with the engine running as this could expose the ecu to an unregulated power supply that could destroy the ecu and other electrical equipment.
5. All fuel system components and wiring should be mounted away from heat sources, shielded if necessary and well vented.
6. Make sure that there are no leaks in the fuel system and that all connections are secure.
7. Disconnect the Gotech ecu when doing any arc welding on the vehicle by unplugging the ecu from the main wiring harness.
8. The engine should be earthed properly.

## **Basic Tools Required For Wiring Installation:**

Some basic tools are required for the Gotech wiring installation, these tools include:

1. Side cutter
2. Wire stripper
3. Insulating tape
4. Soldering iron
5. Solder

Using heat shrink helps tidy up and insulate all the joints. A neat wiring harness makes fault finding easier and compliments the vehicle. Please use the Gotech wiring colour codes as far as possible.

## **You will need the following components fitted prior to the Gotech installation:**

1. High pressure fuel pump capable of a continuous pressure of 3.5bar.
2. Fuel pressure regulator
3. Fuel injectors matched to the engine requirement.
4. Throttle body with throttle position sensor. Throttle position sensor is only required on vehicles with high duration camshafts or normally aspirated race cars.
5. Oil / Water temperature sender unit (Gotech calibrated preferred)
6. A locked (no internal advance) electronic distributor setup or a crank trigger wheel / sensor combination.
7. Good quality suppressed HT leads.

The list above is basic and some extra parts will be required for the complete Gotech installation. Please consult with a experienced Gotech technician on if any other parts are required for the Gotech installation on your specific vehicle.

### **NOTES:**

Installation of engine management systems is a complex exercise to be undertaken only after careful planning and research into the application for which the project is to be used. Damage to engine components is a distinct possibility if care is not taken during the installation and setup of the Gotech engine management system. If you are unsure about how to wire any components of your engine, please consult and experiences installer for advice.

## **Hardware Installation:**

Locate a convenient mounting position for the ecu. It is recommended that the ecu should be installed in the drivers compartment and shielded from any water or moisture.

Plug the harness into the ecu, and feed all wires except for the potentiometer through the firewall. A good seal around the wiring is necessary to prevent engine fumes from entering the cockpit and to protect the wiring.

## Plug Pinouts Gotech MFI Pro:

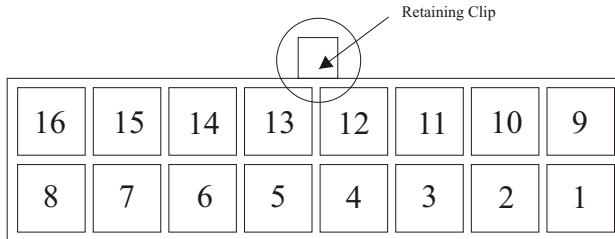

FIG 1.16 PIN MALE PLUG ON THE ECU

### Plug Pin Out References - 16 Pin Plug - MFI PRO

1.	Ground 12 V -	Brown 1.5 mm
2.	Ign Input from crank trigger sensor	Red Shielded 0.5 mm (C/P3)
3.	Ign Output to Coil 4	Black / White 1 mm
4.	Shift Light or Fuel Pump Output	Black / Blue 1 mm
5.	Variable Valve Timing Output	Yellow / Black 1 mm
6.	RPM Output	Red / Black 0.5 mm
7.	Injectors Bank 1 - Positive	Red 1.5 mm
8.	Positive 12 V From Relay Pin 87	Black 1.5 mm
9.	Ground 12 V -	Brown 1.5 mm
10.	Ign Output to Coil 1	White / Green 1 mm
11.	Ign Output to Coil 2	Red / White 1 mm
12.	Injectors Bank 1 Neg Pulse Out	Brown / Orange 1.5 mm
13.	Ign Output to Coil 3	Blue / White 1.5 mm
14.	Injectors Bank 2 Neg Pulse Out	Brown / Red 1.5 mm
15.	Injectors Bank 2 - Positive	Red 1.5 mm
16.	Positive 12 V From Relay Pin 87	Black 1.5 mm

**WARNING:**

Incorrect wiring connections will cause severe damage to the ecu and the vehicle. When routing the wiring harness try to keep it as far away as possible from HT leads and high heat sources like the turbo charger or exhaust headers. Always use good insulation tape and solder the wires properly.

**Plug Pinouts Gotech MFI Pro Continued:**

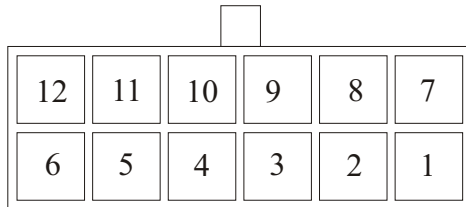

FIG 2. 12 PIN MALE PLUG ON THE ECU

Plug Pin Out References - 12 Pin Plug - MFI PRO

1.	Positive 5 V to TPS Sensor	Orange 0.5 mm
2.	Signal Ground Output to Sensors	Brown / White 0.5 mm
3.	Signal Ground Output to Sensors	Brown / White 0.5 mm
4.	Not Used	Green 0.5 mm
5.	Lambda Sensor Input	Black / Green 1 mm
6.	Air Temp Sensor Input	Blue 0.5 mm
7.	Positive 5 V to Potentiometer	Orange 0.5 mm
8.	Launch Control	Green / White 0.5mm
9.	Input Signal from Potentiometer	Yellow 0.5 mm
10.	External Map Sensor Input	Not Used
11.	Water Temp Sensor Input	Blue / Orange 0.5 mm
12.	Throttle Position Sensor Input	Blue / Yellow 0.5 mm

**WARNING:**

Always disconnect the car's battery before working on the wiring. Avoid open sparks, flames or operation of electrical devices near flammable substances. Disconnect the Gotech ecu when doing any arc welding on the vehicle by unplugging the ecu from the main wiring harness.

## Gotech ECU Power Supply:

The Gotech ecu requires a stable power and earth feed to function properly. It is recommended to fit a high quality 4 pin relay with a inline fuse on the 12v + input of the Gotech ecu. The two Brown wires (16 Pin Plug, Pin 1 and Pin 9) should be connected straight onto the battery negative terminal.

## Connecting the ECU Power Supply:

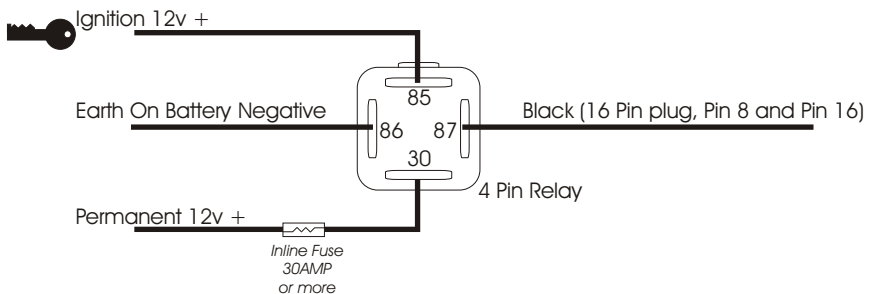

The ignition 12v + wire should give power to the relay pin 85 when the ignition is turned on and while the engine is cranking.

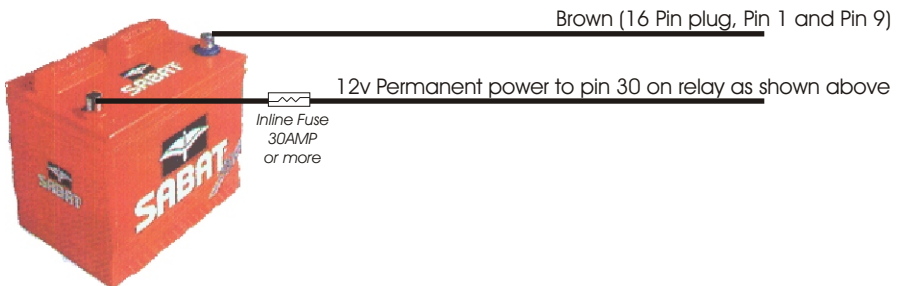

**WARNING:**

Do not reverse the polarity on the Gotech ecu. Reverse polarity will cause severe damage to the Gotech ecu and other electrical parts.

## Fuel injectors:

The fuel injectors is electronically controlled with the ecu. The main purpose of the fuel injector is to deliver fuel to the engine.

The ecu uses switched injector drivers that can control the current passing through an injector by switching the low side of the injector between 12v and ground while the injector is open.

When using second hand fuel injectors it is recommended to clean them with a fuel injector cleaning machine. The most important cause for fuel injector failure or damage is a deep heat soak cycle after the engine is turned off. The remaining fuel inside the injector evaporates, leaving a residual coating and fuel deposits. As these deposits build up, it slowly chokes off the fuel volume at the injector nozzle, and continues to form inside the injector body, until the injector is clogged. Fuel volume is reduced, spray pattern is de-formed, and atomization quality diminishes. Some-times, deposits can result in injector leakage or sluggish operation which can cause rich running conditions. Various drive ability and emission problems can result from this condition. Gotech offers fuel injectors cleaning at reasonable prices.

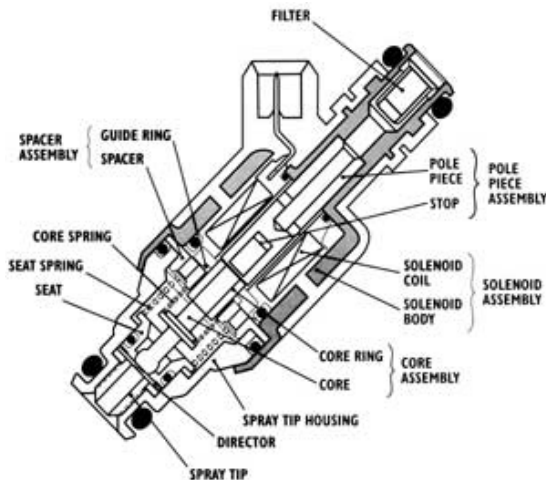

## Fuel injector Outputs:

The Gotech MFI Pro TS ecu offers two fuel injector outputs. These outputs are negative switching and can drive eight 12 ohm fuel injectors. The injector time is configurable up to 14ms (milliseconds).

## Fuel Injector Connection:

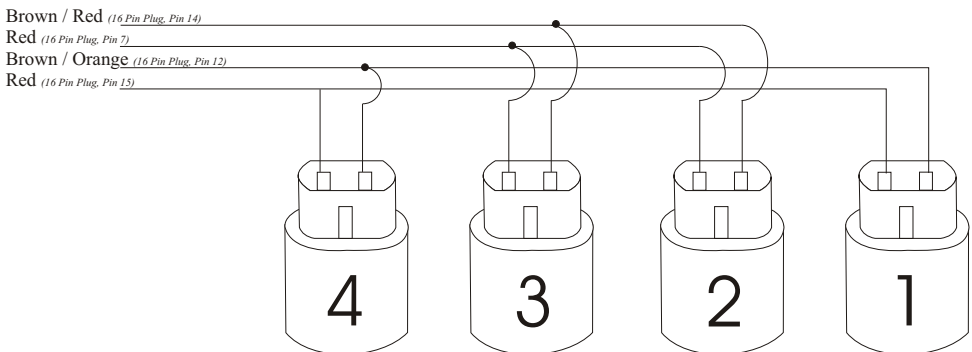

## **Ignition Outputs Gotech MFI Pro:**

The ignition outputs on the Gotech MFI Pro TS ecu is used to trigger the coil(s). The coil(s) can be triggered directly from the ecu or external coil drivers can be used if preferred. The coil(s) should be negative triggering, a special ecu can be built for positive triggering coils on request. This system is capable of controlling either “intelligent” ignitors such as the popular Tp100 ignitor which has in-built dwell control or “dumb” ignitors which contain no such control. This allows standard ignitors to be used in many cases. Most standard ignitors are dumb ignitors. Take great care when setting up the Gotech main settings especially the internal / external features and coil charge time.

The four ignition outputs on the Gotech MFI Pro TS ecu are:

Black / White (16 Pin Plug, Pin 3)

White / Green (16 Pin Plug, Pin 10)

Red / White (16 Pin Plug, Pin 11)

Blue/ White (16 Pin Plug, Pin 13)

### ***Coil charge time:***

Coil charge time is the milli seconds (ms) that the coil or ignition module will be charged. This value is fully configurable through the Gotech dealer tune software. The recommended coil charge time is 2.00 ms. The coil charge time can be increased up to 4.00 ms. When running a higher coil charge time be sure to keep an eye on the ecu, ignition module and coil temperatures. If the coil charge time is too high or too low the engine will missfire or hesitate to rev up.

## Ignition Outputs Gotech MFI Pro Continued:

### Connecting the coils and ignition modules:

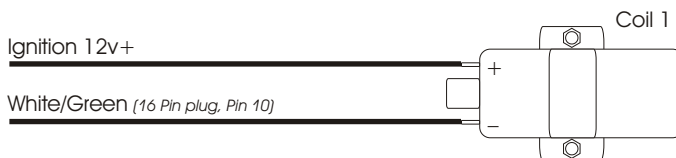
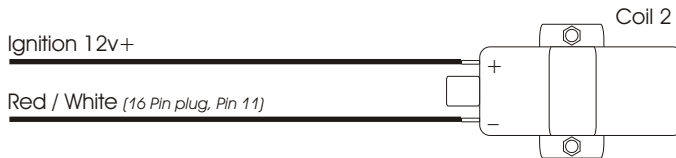
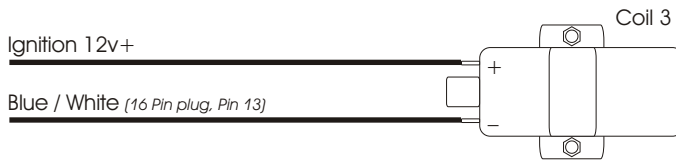
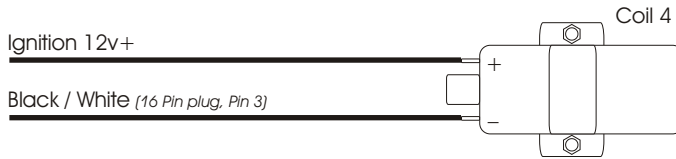

+ = 12v+

- = signal

E = Earth

Nissan Sr20 DET

## Signal Input Gotech MFI Pro:

The signal input (*Red in shielded 16 Pin Plug, Pin 2*) is used as a reference by the Gotech ecu of the engine speed. A magnetic, optical or hall effect sensor can be used for the signal input. On some magnetic sensors you will need a Tp500 ignition module to amplify the input signal.

## Connecting The Input Signal:

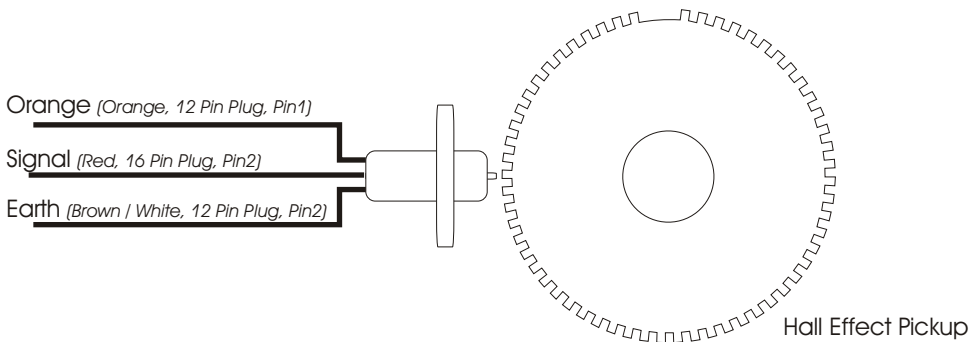
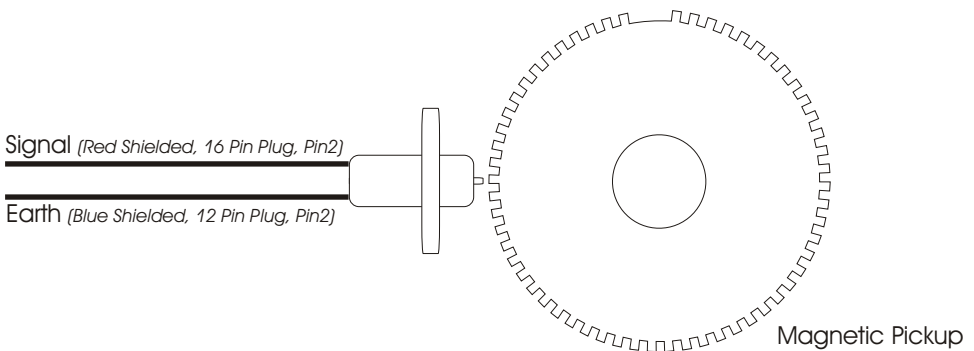

## Signal Input Gotech MFI Pro Continued:

### Crank Angle Sensors And Wheels:

The Gotech MFI Pro TS ecu can be used with various crank angle devices including the popular 60 -2 and 36 -1 setups. We can also supply universal 60 -2 trigger wheels and crank angle sensors, please contact us for more details on these units. When fitting the 60 -2 trigger wheel on your crank pulley the crank trigger wheel should be properly aligned. It is best to send the crank pulley with the 60 -2 trigger wheel for balancing after the unit has been fitted.

### Trigger Teeth Compensation MFI PRO ECU:

The usable range is 9 to 16 teeth. This function is used to compensate for the mounting position of the crank trigger signal generator (pickup). After mounting the pickup turn the engine to TDC. Mount the 60- 2 tooth wheel in a convenient position so that the pickup lines up with the 12<sup>th</sup> or 13<sup>th</sup> tooth. It does not matter where the gap in the tooth wheel ends up being, as long as the pickup is within the specified range with the engine at TDC. Take into account the direction of rotation. This gives you some adjustment up or down should the TDC mark not align properly. See Fig 6 on the next page. When matching the timing the appropriate trigger tooth value should be selected according to your engine setup. The trigger tooth setting is adjustable in the Gotech software main setup screen.

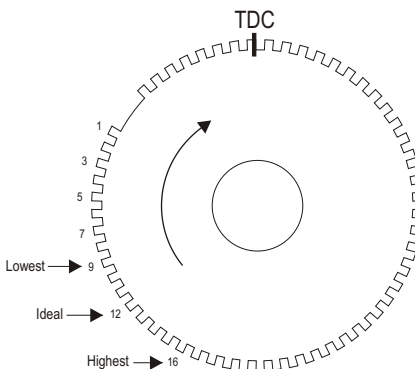

The crank trigger sensor bracket should be sturdy and not vibrate when the engine is running. Any vibrations will lead to signal loss. The air gap between the crank angle sensor and the 60 -2 trigger wheel should be no more than 0.3mm. The crank angle sensor should not touch the 60 -2 trigger wheel when the engine is turning.

## Throttle position Sensor:

Most modern fuel injected vehicles are fitted with a TPS (Throttle position sensor). The ecu uses the TPS as a reference to how far the throttle is opened. A TPS is not a critical element of the input sensors and can be substituted with the built in map sensor. If the vehicle is equipped with high duration camshafts then a TPS is required. On turbo or super charged vehicles using forced induction it is recommended to run the map sensor as primary input. (Mode 0 in TPS map mix on the f5 configuration screen). A TPS is basically a variable resistor as shown in fig 1.1.

TPS connection on Gotech harness:

Blue / Yellow (12 Pin Plug, Pin 12) - Signal  
 Orange (12 Pin Plug, Pin 7) - Positive  
 Brown / White (12 Pin Plug, Pin 2) - Negative

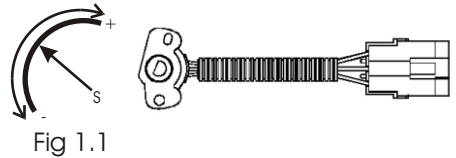

## Determining the pinouts of a tps:

Take a multimeter and switch it to measure ohmage. On a three pin tps when measuring between positive and negative the ohmage will stay the same when opening the throttle. Between positive and signal the ohmage will go less when opening the throttle. Between negative and signal the ohmage will increase when opening the throttle.

## Popular engine's TPS pinouts:

VW Golf mp9  
 Pin 4 - Negative  
 Pin 5 - Signal  
 Pin 7 - Positive

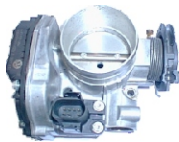

Toyota 4age  
 Pin 1 - Positive  
 Pin 2 - Signal  
 Pin 4 - Negative



VW Golf 3 Pin  
 Pin 1 - Negative  
 Pin 2 - Signal  
 Pin 3 - Positive



## Water Temperature:

The Gotech ecu uses the water temperature sensor as a reference to see how hot the engine is for cold starting purposes. On air cooled engines the temperature sensor can be mounted to sense oil temperature. Most oem water temperature sensors can be used with the Gotech ecu, but it is recommended to use the Gotech temp sender unit as seen in fig 1.2 (Available from Gotech).

### Water Temperature Sensor Connection:

- Blue / Orange (12 Pin Plug, Pin 11) - Signal
- Brown / White (12 Pin Plug, Pin 2) - Negative

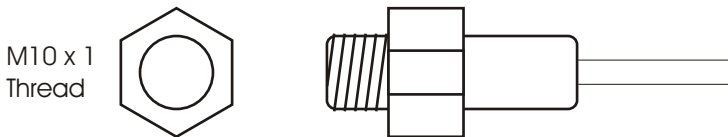

Fig 1.2

## Air Temperature:

The air temperature sensor is supplied with the Gotech wiring harness as seen in fig 1.3. This sensor gives the ecu an indication of the outside air temperature and then enriches the fuel mixtures accordingly. The air temperature sensor should be fitted on the vehicle so that it does not receive hot air from the engine compartment. A threaded air temperature sensor is available on request.

### Air Temperature Sensor Connection:

- Blue (12 Pin Plug, Pin 6) - Signal
- Brown / White (12 Pin Plug, Pin 2) - Negative



Fig 1.3

## Lambda Sensor:

When setting up the ecu a Lambda sensor should be used, but it is not required for everyday driving. The Lambda sensor must be mounted in the exhaust pipe near the exhaust header or extractor, usually after the collector. The sensor uses the exhaust gas to detect if the engine is running lean or rich.

## Lambda Sensor Installation:

The most common sensor used is a four wire Bosch Lambda sensor. This sensor is equipped with a built in heater element.

Colour codes for the Bosch four wire Lambda sensor:

White - 12v positive (Can be on either one of the white wires)

White - Earth (Can be on either one of the white wires)

Gray - Earth from instrument (brown / white, *12 Pin Plug, Pin 2*)

Black - Signal (Black / Green, *12 Pin Plug, Pin 5*)

## Closed Loop Lambda Control: (v4 chipset upwards)

Closed loop lambda control uses the Lambda sensor to check the exhaust o2 content and then changes the fuel maps accordingly. All the parameters are fully configurable in the Gotech software. It is not recommended to use the closed loop lambda control on turbo charged vehicles or more than 25% throttle on normally aspirated vehicles. For more info on setting up the closed loop please refer to software manual on the software cd supplied with the ecu.

Bosch 4 Wire  
M18 x 1.5  
Thread

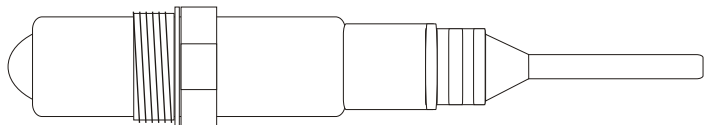

Fig 1.3

**WARNING:**

A lambda sensor can easily be damaged by oil and debris in the exhaust system. Take care never to drop the lambda sensor as it may lead to permanent damage. Most Lambda sensors are intended for unleaded gasoline only and will not last long with leaded gasoline. Normally when a lambda sensor packs up the reading goes to 14.7 and does not change when you enrich the engine.

### Optional Output Gotech MFI Pro:

The optional output on the Gotech MFI Pro ecu (*Yellow / Black, 16 Pin Plug, Pin 5*) can be used for various purposes including the activation of Nitrous oxide, Variable Valve Timing (VVT) or Water spray jets on the radiator or intercooler.

The optional output is RPM based and can be switched on at a certain RPM and switched off again at another RPM. The output is switched negatively and a relay should always be used. The on and of RPM values is fully configurable with the Gotech software.

### Connecting The Optional Output:

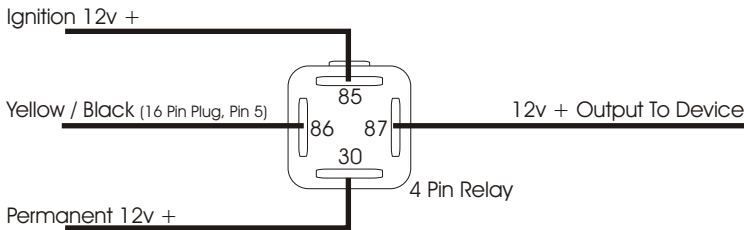

### Fuel Pump Output Gotech MFI Pro:

The fuel pump output on the Gotech MFI Pro ecu (*Black / Blue, 16 Pin plug, Pin 4*) can be used to switch on a fuel pump relay or for an externally mounted shift light. The output is switched negatively and a relay should always be used. The on RPM is fully configurable with the Gotech software.

### Connecting The Fuel Pump Output:

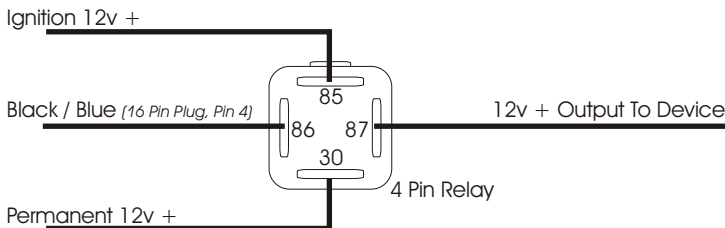

## Rev Counter Output Gotech MFI Pro:

The rev counter output (Red / Black 0.5mm, 16 Pin Plug, Pin6) on the Gotech MFI Pro ecu can be used to drive an externally mounted rev counter. In some cases the RPM output from the Gotech MFI Pro ecu is not strong enough to drive the rev counter, a tach adaptor is then required for the rev counter to operate normally.

### Connecting The Rev Counter:

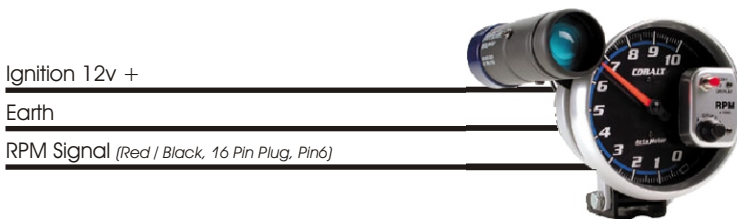

### Gotech Tach Adaptors: (optional extra if required)

The Gotech tach adaptor amplifies the RPM signal from the Gotech MFI Pro ecu so that the rev counter can work properly. A tach adaptor is not required on all rev counters.

### Connecting The Tach Adaptor:

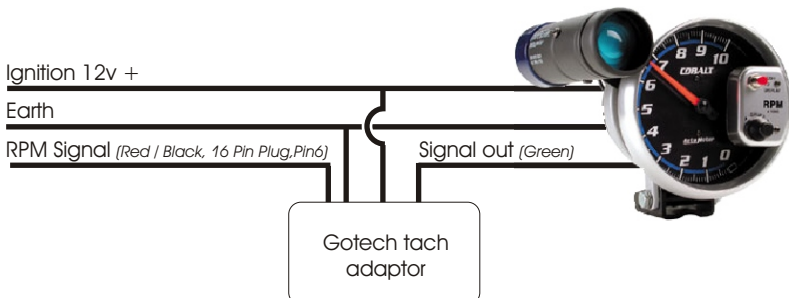

## Launch Control:

The launch control feature is available on Gotech MFI Pro v4 and upward ecu's. Please specify to have the launch control activated when you purchase your ecu as this is an optional feature.

When the launch control is activated the ignition timing is retarded (amount configurable) and the soft and hard launch rpm limit is used (rpm configurable). With your foot flat on the throttle the engine will limit on the launch rpm limit. As soon as you pull away you release the button and the timing will be advanced again to the original ignition map after a couple of ms (time configurable) and the rpm limit will go back to the standard value. With the launch control activated on a turbo vehicle you will notice that the engine will start to boost when the launch rpm limit is reached. This will help to bring down the turbo lag on a vehicle with a big turbo setup. Setting up the launch control may take a while and you will need to spend a couple of hours at the race track to perfect your settings and win that extra couple of tenths at the end of the 1/4 mile.

## Activating The Launch Control:

Connect the green / white (12 Pin Plug, Pin 8) wire and the orange to activate the launch control. We recommend fitting a on/of switch in your vehicle with a push button on the steering.

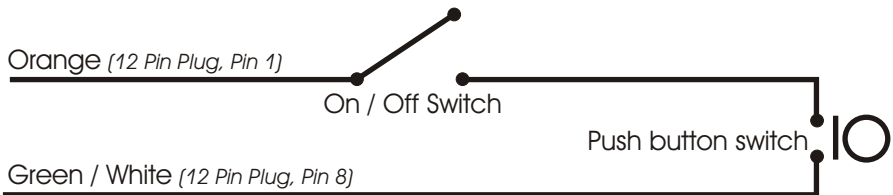

**WARNING:**

The launch control function should only be used by advanced users. By setting the launch control values incorrectly you can seriously damage your vehicle's engine and the Gotech ecu. This function is intended for track use only.